

basalte

Simplicity is the ultimate sophistication.

Leonardo Da Vinci

Home automation should be simple and add comfort to the complexity of the modern home.

Home automation systems are often designed from a technical point of view, while we believe that one should be able to control everything in an intuitive and simple way.

TACTO

In our search for simplicity, we have created a new user experience using innovative touch sensitive technology, which makes the entire surface sensitive to touch.

As a single function switch, Tacto switches or dims lights, controls scenes and blinds at only the slightest touch without pointing to a specific area.

Touching Tacto for a longer period starts the unique scene sequencer function, which allows selecting up to four additional scenes.

The integrated multicolour LED backlight makes Tacto visible in the dark and can also be used for status feedback.

Using the integrated RGB sequencer, Tacto allows controlling RGB lights in a very simple and intuitive way.



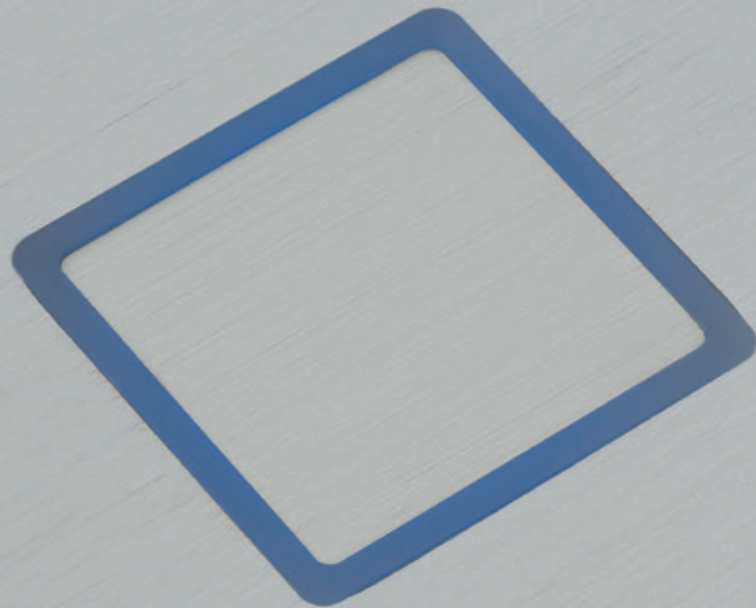



111-01 brushed aluminium

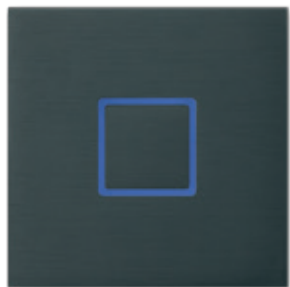

111-02 brushed dark grey

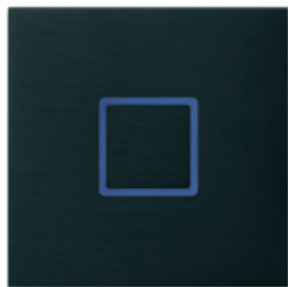

111-03 brushed black



111-04 satin white

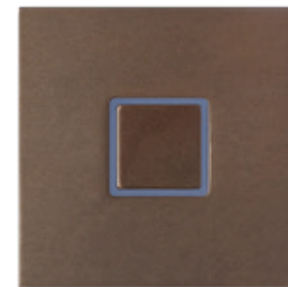

111-05 bronze

- 1 touch surface
- advanced short and long press behaviour
- integrated scene sequencer or RGB sequencer
- multicolour LED backlight
- dimensions: 80mm x 80mm x 6mm
- combined with 100-02 BCU for KNX



reddot design award
winner 2007

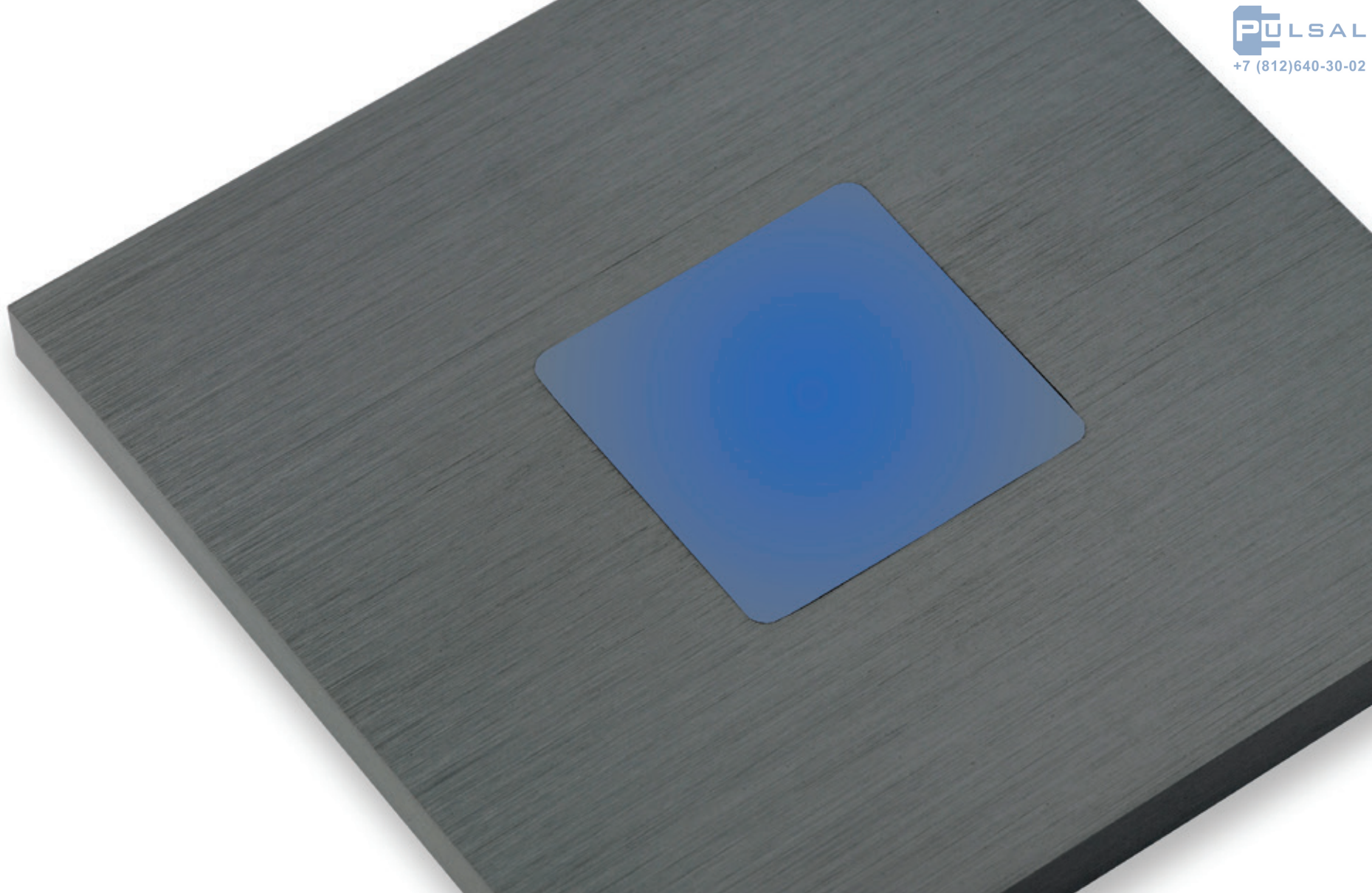



101-01 brushed aluminium

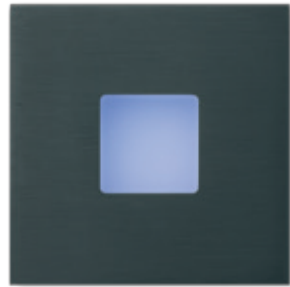

101-02 brushed dark grey

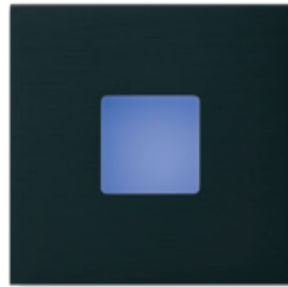

101-03 brushed black



101-04 satin white



101-05 bronze

- 1 touch surface
- advanced short and long press behaviour
- integrated scene sequencer or RGB sequencer
- multicolour LED backlight
- dimensions: 80mm x 80mm x 6mm
- combined with 100-02 BCU for KNX



reddot design award
winner 2007

MONA

Mona is a sensually designed light switch with a finely drawn geometric stylistic language. Harmoniously it seems to melt into the wall. With its simple, architectural shape it goes with any style.

Mona features a touch-sensitive surface allowing comfortable and elegant handling, and offers the same unique functionalities as Tacto.

In switched-off position, light emitting diodes illuminate the light switch with a softly shimmering ring.







102-03 black



102-04 white

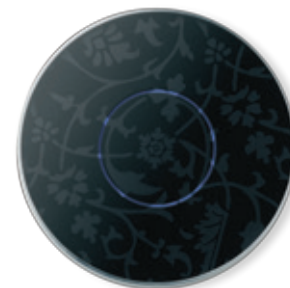

102-05 flower

- 1 touch surface
- advanced short and long press behaviour
- integrated scene sequencer or RGB sequencer
- multicolour LED backlight
- dimensions: Ø 80mm x 6mm
- combined with 100-02 BCU for KNX



reddot design award
winner 2009

SENTIDO

Sentido, the light switch reinvented.

The basic idea of Sentido is very simple, yet very innovative.

Divide a square in equal surfaces that each control different functions. The entire surface is touch-sensitive, creating a very easy and unique way of control.

Touching more than one surface at the same time turns on and off all the lights in a room using a general scene. This multi-touch function makes light control highly intuitive and user friendly.

Touching multi-touch for a longer period starts the unique scene sequencer function, which allows selecting up to four additional scenes.

The internal temperature sensor discretely reports the room temperature to the home automation system while the integrated thermostat logic controls the heating and air-conditioning of the room.

The multicolour LED backlight can be used for status feedback or simply to light up Sentido in the dark.

Using the integrated RGB sequencer in combination with multi-touch allows controlling RGB lights in a very simple and intuitive way.

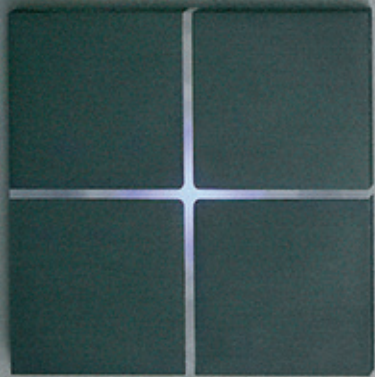



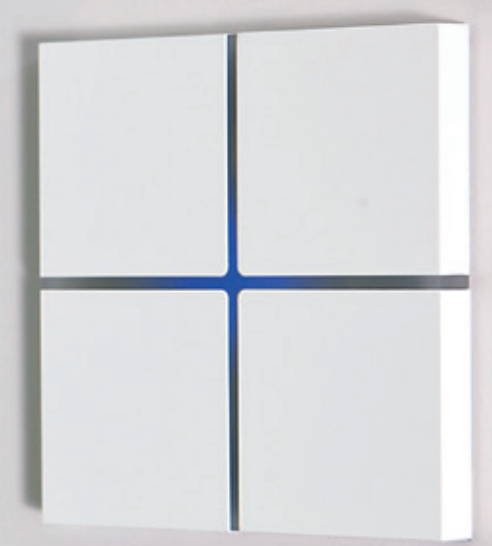

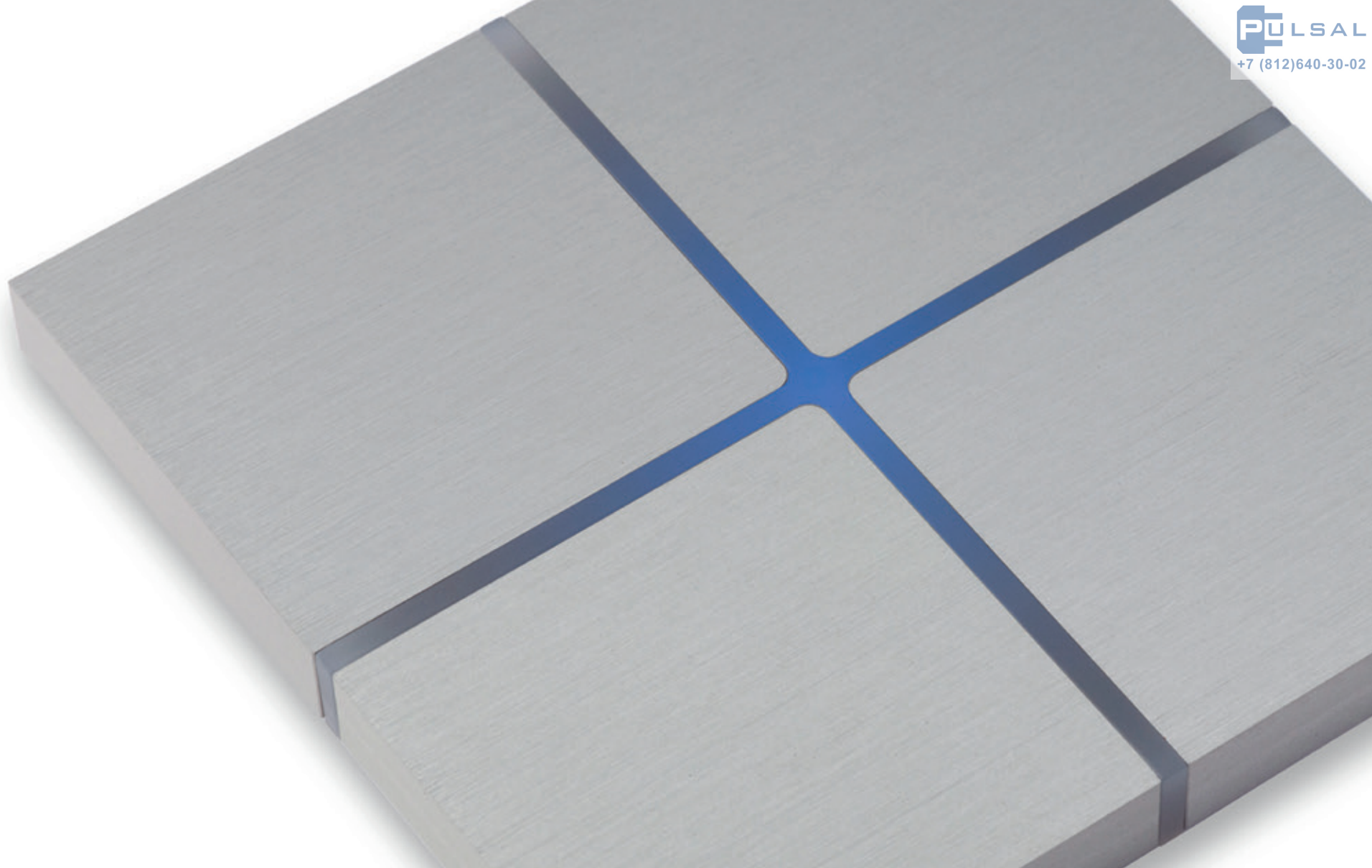

sentido

4-way aluminium

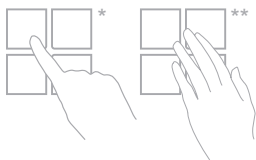

202-01 brushed aluminium



202-02 brushed dark grey



202-03 brushed black



202-04 satin white

- 4 single touch surfaces *
- 1 multi-touch **
- integrated scene sequencer or RGB sequencer
- multicolour LED backlight
- temperature sensor with integrated thermostat logic
- dimensions: 80mm x 80mm x 8mm
- combined with 200-02 BCU for KNX

DESIGN PLUS
2008



reddot design award
winner 2008

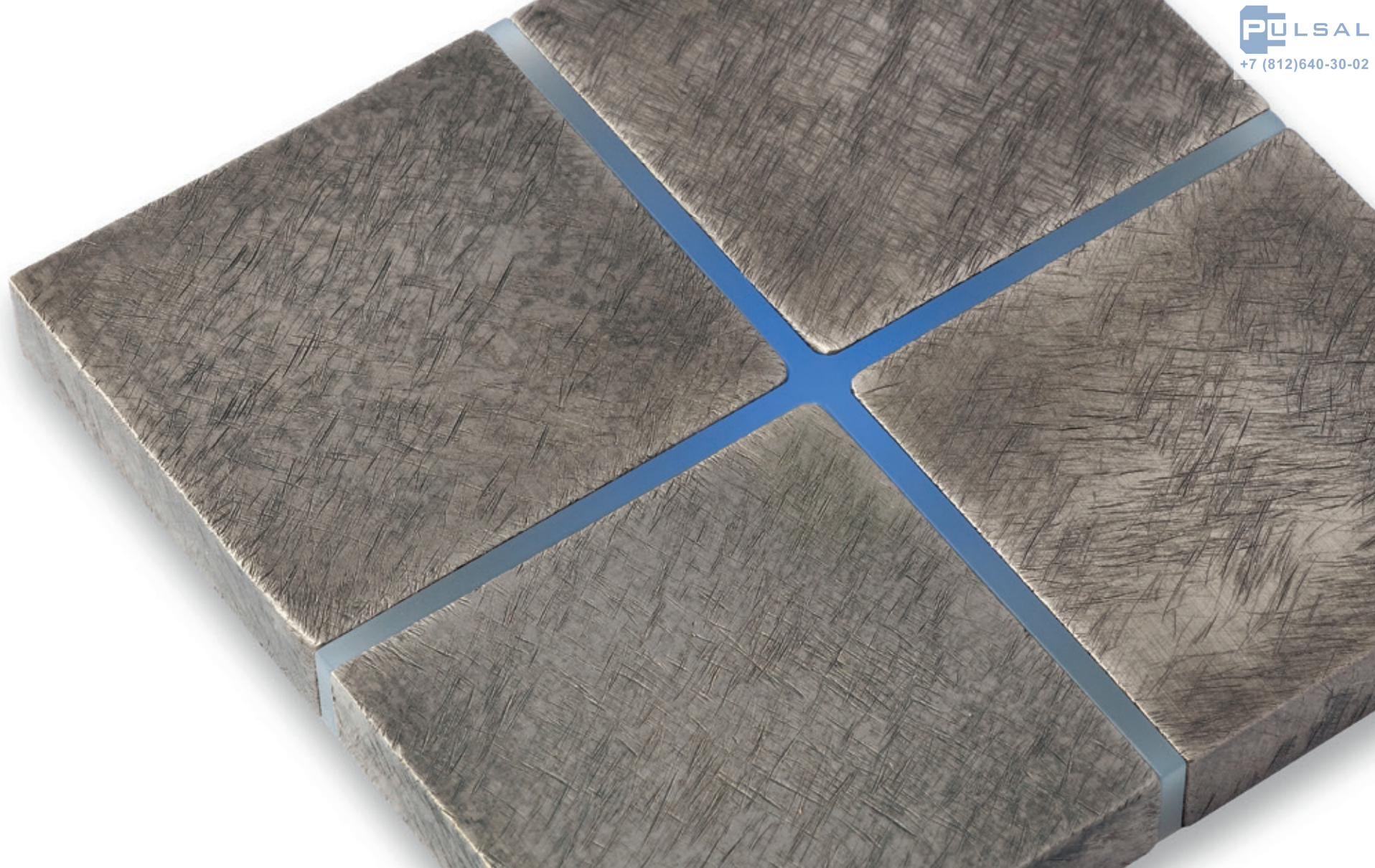

sentido

4-way classic

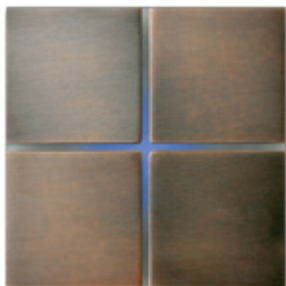
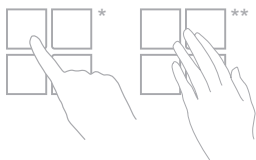

202-05 bronze

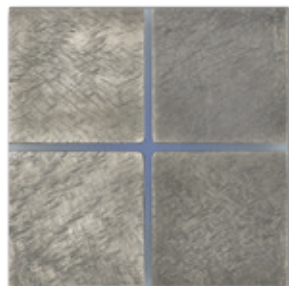

202-06 fer forgé



202-07 brushed nickel



202-08 brushed brass

- 4 single touch surfaces *
- 1 multi-touch **
- integrated scene sequencer or RGB sequencer
- multicolour LED backlight
- temperature sensor with integrated thermostat logic
- dimensions: 80mm x 80mm x 8mm
- combined with 200-02 BCU for KNX

DESIGN PLUS
2008



reddot design award
winner 2008



sentido

2-way aluminium

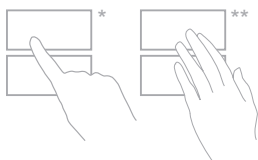

201-01 brushed aluminium



201-02 brushed dark grey



201-03 brushed black



201-04 satin white

- 2 single touch surfaces *
- 1 multi-touch **
- integrated scene sequencer or RGB sequencer
- multicolour LED backlight
- temperature sensor with integrated thermostat logic
- dimensions: 80mm x 80mm x 8mm
- combined with 200-02 BCU for KNX

DESIGN PLUS
2008



reddot design award
winner 2008

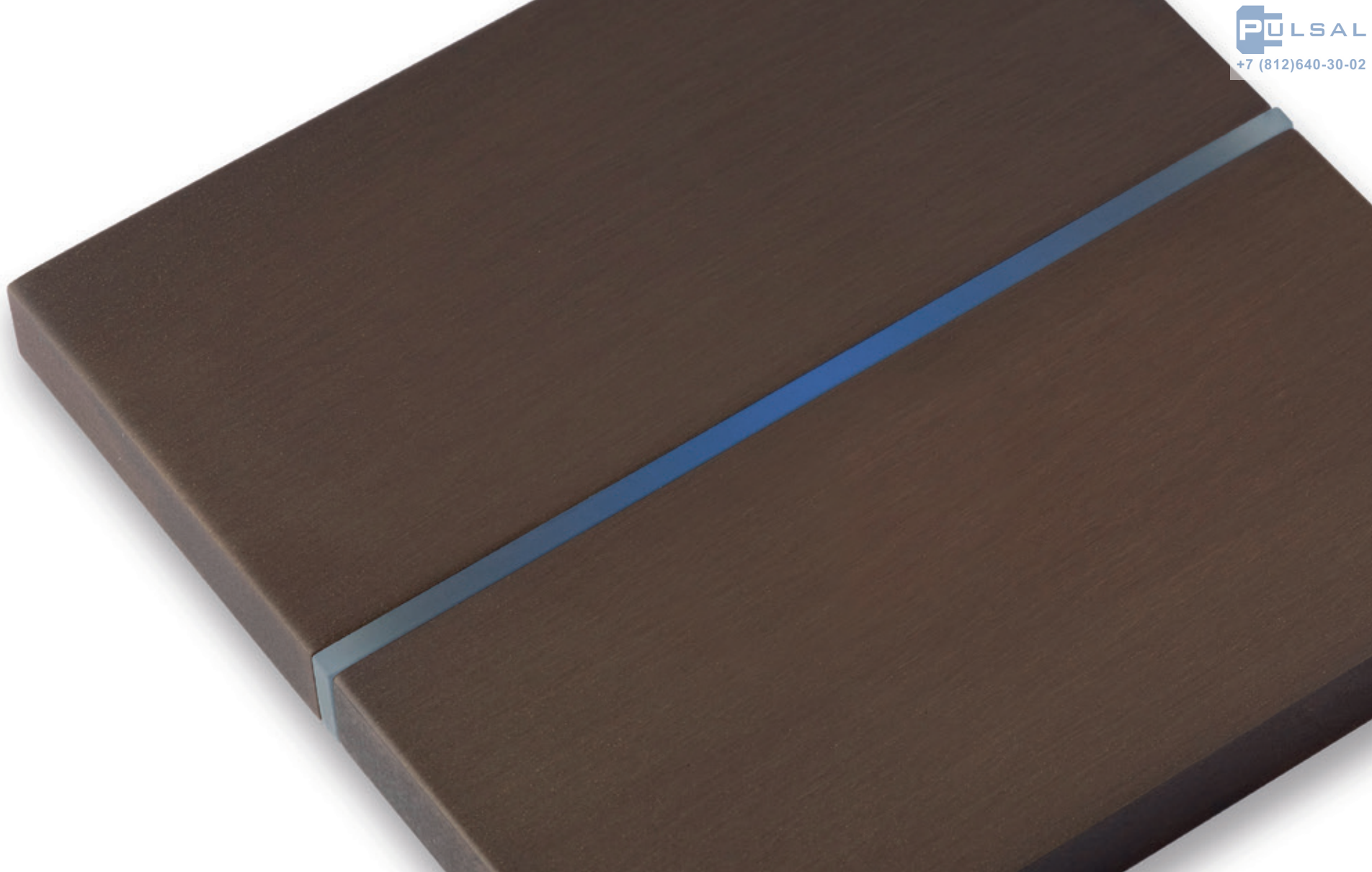

sentido

2-way classic

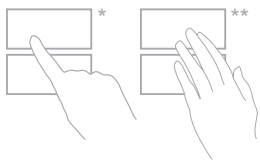

201-05 bronze

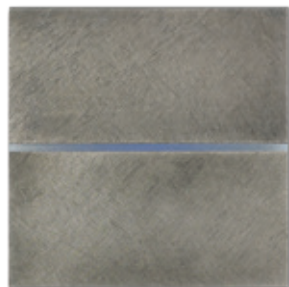

201-06 fer forgé



201-07 brushed nickel

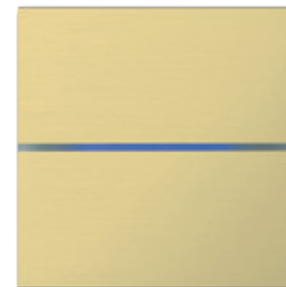

201-08 brushed brass

- 2 single touch surfaces *
- 1 multi-touch **
- integrated scene sequencer or RGB sequencer
- multicolour LED backlight
- temperature sensor with integrated thermostat logic
- dimensions: 80mm x 80mm x 8mm
- combined with 200-02 BCU for KNX

DESIGN PLUS
2008



reddot design award
winner 2008

ENZO

Inspired by Italian design of the late fifties, Enzo combines retro with luxury based on craftsmanship and high quality materials.

The fine rounded border is made of polished aluminium while the inlay can be leather or glass.

Despite its retro look, Enzo uses the latest technology and features highly sensitive touch sensors, multi-touch capability and temperature control.

Enzo offers the same unique and innovative functionalities as Sentido.

The integrated multicolour LED backlight makes Enzo visible in the dark and can also be used for status feedback.



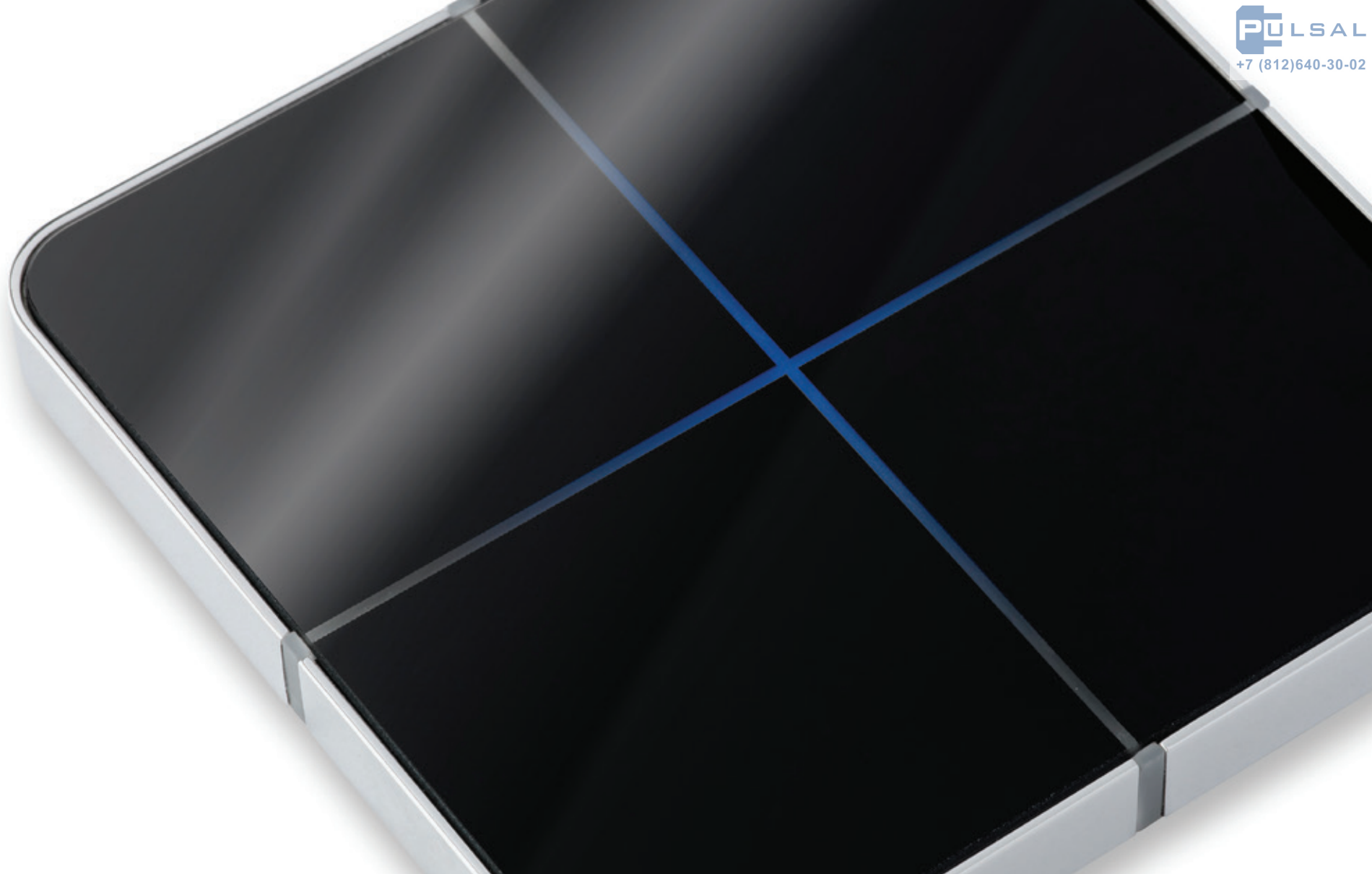

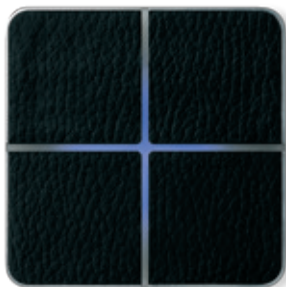
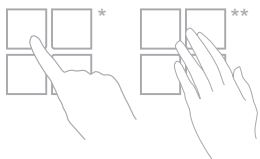

204-13 black leather



204-14 white leather



204-03 black glass



204-04 white glass

- 4 single touch surfaces *
- 1 multi-touch **
- integrated scene sequencer or RGB sequencer
- multicolour LED backlight
- temperature sensor with integrated thermostat logic
- dimensions: 80mm x 80mm x 8mm
- combined with 200-02 BCU for KNX



Designpreis
Deutschland
2010

NOMINEE

best of
DESIGN PLUS
2010



reddot design award
winner 2010



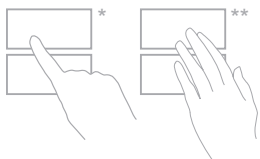

203-13 black leather



203-14 white leather



203-03 black glass



203-04 white glass

- 2 single touch surfaces *
- 1 multi-touch **
- integrated scene sequencer or RGB sequencer
- multicolour LED backlight
- temperature sensor with integrated thermostat logic
- dimensions: 80mm x 80mm x 8mm
- combined with 200-02 BCU for KNX



Designpreis
Deutschland
2010

NOMINEE

best of
DESIGN PLUS
2010



reddot design award
winner 2010

D E S E O

At first look, Deseo is a beautiful intelligent thermostat. But in fact, Deseo is much more than just a thermostat.

Discrete and minimalistic, Deseo offers a simple and innovative user interface. Highly sensitive touch sensors allow you to navigate through all the functions in a room. Lights, scenes, shutters and blinds, even the multi-room audio system can be controlled at the slightest touch.

We call it; a room controller.

This innovative concept allows light switches in a room to remain simple and to control only the most important functionalities. All other, less important functions can be controlled with Deseo.

And as Sentido, a simple multi-touch will start a welcome or goodbye scene.

Deseo, because we like to keep things simple.



15:35
20.6°C

deseo

room controller aluminium

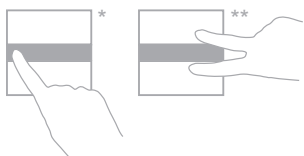

301-01 brushed aluminium



301-02 brushed dark grey



301-03 brushed black

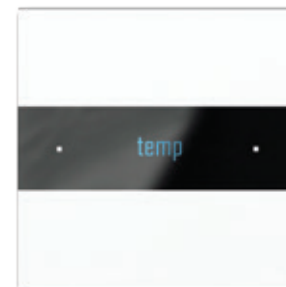

301-04 satin white

- touch controlled menu *
- 1 multi-touch **
- 1.7" oled display
- temperature sensor with integrated thermostat logic
- dimensions: 80mm x 80mm x 8mm
- combined with 300-02 BCU for KNX



reddot design award
winner 2011

15:35
20.6°C

deseo

room controller classic

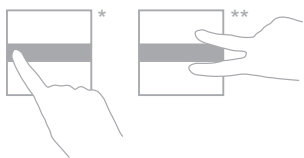

301-05 bronze



301-06 fer forgé



301-07 brushed nickel



301-08 brushed brass

- touch controlled menu *
- 1 multi-touch **
- 1.7" oled display
- temperature sensor with integrated thermostat logic
- dimensions: 80mm x 80mm x 8mm
- combined with 300-02 BCU for KNX



reddot design award
winner 2011

A close-up, angled view of a white, rectangular electronic device with rounded corners. A black horizontal strip across the middle contains a digital display in blue. The display shows the time "15:35" and the temperature "20.6°C".

15:35
20.6°C

deseo

room controller retro

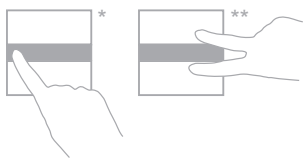

301-13 black leather



301-14 white leather



301-23 black glass



301-24 white glass

- touch controlled menu *
- 1 multi-touch **
- 1.7" oled display
- temperature sensor with integrated thermostat logic
- dimensions: 80mm x 80mm x 8mm
- combined with 300-02 BCU for KNX



reddot design award
winner 2011

AURO

Auro is everything what a motion detector should be, small, fast and almost invisible. When mounted in the ceiling, the innovative flat design makes Auro completely blend in. Only requiring an opening of 43mm, it is very easy to install.

Auro has a built in light sensor for light dependent switching, dimming and controlling scenes and can even behave differently during day or night.

The internal temperature sensor discretely reports the room temperature to the home automation system while it can also be used to trigger a heat alarm in case of a fire.

With a vertical detection angle of 90° it has a detection area with a diameter of 5m when installed at a height of 2.5m, making it perfect for hallways, toilets and small rooms.





auro

motion detector



180-02 white



180-03 black

- completely flat design
- visible diameter 52mm
- visible thickness 1mm
- 360° range horizontal
- 90° range vertical
- integrated LED feedback
- integrated lux sensor (only white version)
- integrated temperature sensor
- available in white and black

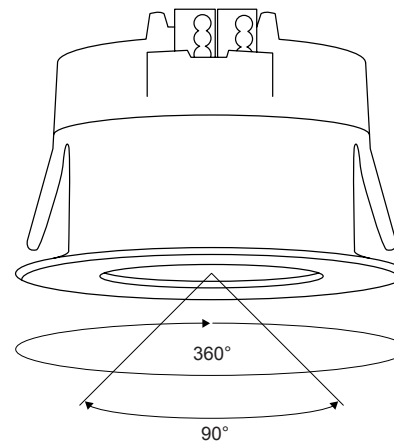
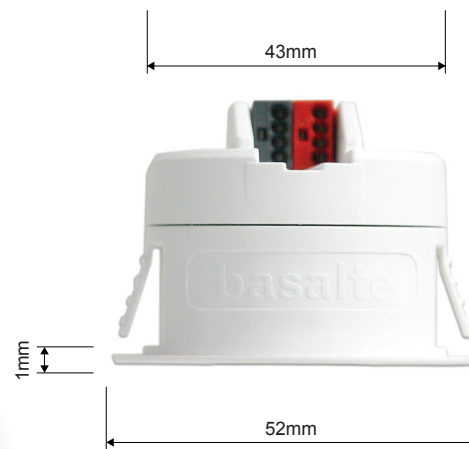

actual size

FRAME

To complement our products with sockets and outlets, we have designed frames with the same finishing as our switches.

These frames can be used in combination with 55mm inserts from all major manufacturers.
The frames are available in 1, 2, 3, 4 and 5-gang.





frame

for 55mm insert
aluminium



brushed aluminium

- 001-01 1-gang
- 002-01 2-gang
- 003-01 3-gang
- 004-01 4-gang
- 005-01 5-gang



brushed dark grey

- 001-02 1-gang
- 002-02 2-gang
- 003-02 3-gang
- 004-02 4-gang
- 005-02 5-gang



brushed black

- 001-03 1-gang
- 002-03 2-gang
- 003-03 3-gang
- 004-03 4-gang
- 005-03 5-gang



satin white

- 001-04 1-gang
- 002-04 2-gang
- 003-04 3-gang
- 004-04 4-gang
- 005-04 5-gang

- dimensions: 1-gang: 80mm x 80mm x 9mm
- 2-gang: 151mm x 80mm x 9mm
- 3-gang: 222mm x 80mm x 9mm
- 4-gang: 293mm x 80mm x 9mm
- 5-gang: 364mm x 80mm x 9mm

- combine with 55-mm insert for sockets and outlets from Schneider/Merten, Gira and Jung



frame

for 55mm insert
classic



bronze

- 001-05 1-gang
- 002-05 2-gang
- 003-05 3-gang
- 004-05 4-gang
- 005-05 5-gang



fer forgé

- 001-06 1-gang
- 002-06 2-gang
- 003-06 3-gang
- 004-06 4-gang
- 005-06 5-gang



brushed nickel

- 001-07 1-gang
- 002-07 2-gang
- 003-07 3-gang
- 004-07 4-gang
- 005-07 5-gang



brushed brass

- 001-08 1-gang
- 002-08 2-gang
- 003-08 3-gang
- 004-08 4-gang
- 005-08 5-gang

- dimensions: 1-gang: 80mm x 80mm x 9mm
- 2-gang: 151mm x 80mm x 9mm
- 3-gang: 222mm x 80mm x 9mm
- 4-gang: 293mm x 80mm x 9mm
- 5-gang: 364mm x 80mm x 9mm

- combine with 55-mm insert for sockets and outlets from Schneider/Merten, Gira and Jung







Design is not just what it looks like and feels like.
Design is how it works.

Steve Jobs

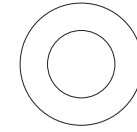
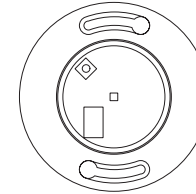
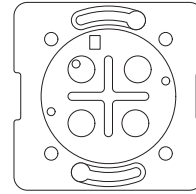
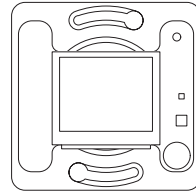
technical specifications

specifications may alter without prior notice



| |  |  |  |  |
|---------------------------------|---|--|---|---|
| name / productnumber | deseo KNX / 300-02 | sentido KNX / 200-02 | tacto KNX / 100-02 | auro KNX / 180-02/180-03 |
| front cover | deseo | sentido and enzo | tacto and mona | - |
| interface | KNX integrated BCU | KNX integrated BCU | KNX integrated BCU | KNX integrated BCU |
| display | 1.7" Oled | - | - | - |
| multi-touch | yes | yes | - | - |
| scene- and RGB sequencer | - | yes | yes | - |
| multicolour LED | - | integrated | integrated | white led integrated |
| temperature sensor | integrated | integrated | - | integrated |
| thermostat logic | integrated | integrated | - | - |
| lux sensor | - | - | - | integrated (only 180-02) |
| power supply | 15 - 30V DC separate from KNX bus | KNX buspower | KNX buspower | KNX buspower |
| power consumption | 1W | 10mA | 10mA | 10mA |
| dimensions | 70mm x 70mm x 30mm | 70mm x 70mm x 25mm | diam: 74mm x 32mm | diam: 52mm x 39mm |
| backbox | European standard box with screws 60mm | European standard box with screws 60mm | European standard box with screws 60mm | cutout diam: 43mm |
| certification | CE | CE | CE | CE |





Who ever said that pleasure wasn't functional?

Charles Eames

basalte

hundelgemsesteenweg 1a

9820 merelbeke

belgium

info@basalte.be

www.basalte.be

© basalte 2014

basalte is a registered trademark of basalte bvba

Pictures shown are indicative only. The actual finishes can have a different surface aspect.

with the support of Flanders **Investment & Trade**
Gouvernement of Flanders - Belgium

www.basalte.be