

## LED universal touch dimmer insert

Art. No. : 1224LEDUDE

### Operating instructions

## 1 Safety instructions



Electrical devices may only be mounted and connected by electrically skilled persons.

Serious injuries, fire or property damage possible. Please read and follow manual fully.

Danger of electric shock. Always disconnect before carrying out work on the device or load. In so doing, take all the circuit breakers into account, which support dangerous voltages to the device and or load.

Danger of electric shock. Device is not suitable for disconnection from supply voltage. The load is not electrically isolated from the mains even when the device is switched off.

Risk of destruction if the set operating mode and load type do not match. Set correct operating mode before connecting or exchanging the load.

Fire hazard. For operation with inductive transformers, each transformer must be fused on the primary side in accordance with the manufacturer's instructions. Only safety transformers according to EN 61558-2-6 may be used.

Do not connect any luminaire with integrated dimmers. Device can be damaged.

Do not connect any LED or compact fluorescent lamps that are not specifically suitable for dimming. Device can be damaged.

Danger of electric shock. Do not operate the insert without a cover.

These instructions are an integral part of the product, and must remain with the end customer.

## 2 Device components

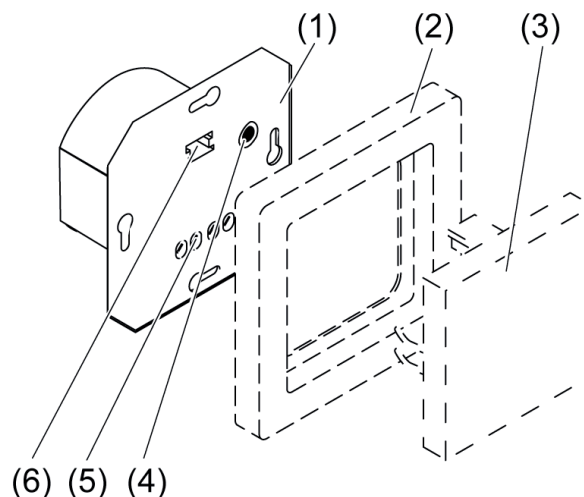

Figure 1: Device components

- (1) FM insert
- (2) Frame
- (3) Cover
- (4) button **Dimm-Mode**
- (5) Terminals

(6) Connection socket for cover and display LED operating mode

### 3 Function

#### Intended use

- Switching and dimming of incandescent lamps, HV halogen lamps, electronic transformers for halogen or LED lamps, dimmable inductive transformers for halogen or LED lamps, HV-LED or compact fluorescent lamps
- Mounting in appliance box according to DIN 49073
- Operation with suitable cover
- i** If inductive and electronic transformers are connected, observe the data of the transformer manufacturer on loads and the dimming principle.
- i** When dimmable LED or compact fluorescent lamps are connected, only connect lamps of one manufacturer and of the same type.
- i** HV-LED and compact fluorescent lamps generate high pulsed currents, when they are operated in the leading edge phase control. Depending on the design and power rating of these lamps, the connected load of the specified values could vary.
- i** Dimming results and dimming quality could vary depending on cable lengths, grid conditions and other influencing factors. Depending on the design and power rating of the lamps, the connected load of the specified values could vary. We cannot assume any guarantee for the function, dimming results and dimming quality in connection with LED lamps.

#### Product characteristics

- Device works according to the leading edge phase control or trailing edge phase control principle
- Automatic or manual setting of the dimming principle suitable for the load
- Display of the set operating mode by means LED
- Device can be operated without neutral conductor
- Switch-on via bulb-preserving soft start
- Switch-on brightness can be saved permanently
- Minimum brightness can be saved permanently
- Connection of extensions possible
- Electronic short-circuit protection with permanent switch-off after 7 seconds at the latest
- Electronic over-temperature protection
- i** Flickering of the connected lamps due to undershoot of the specified minimum load or through centralised pulses from the power stations. This does not represent any defect in the device.
- i** Brief flickering upon load detection possible. No operation is possible during load detection.
- i** Power extension possible by means of power boosters. Do not connect any LED lamps or compact fluorescent lamps in combination with power boosters.

### 4 Operation

These instructions describe operation with a button cover (see Accessories). Operation with a different cover is described in the instructions for the cover in question. Operation on the main device or 2-wire extension is identical.

- i** Extension operation is only possible if there is a cover fitted on the main device.

#### Switch light

- Press button for less than 0.4 seconds.

#### Adjust the brightness

Light is switched on.

- Press button at top for longer than 0.4 seconds.  
The light gets brighter up to maximum brightness.
- Press button at bottom for longer than 0.4 seconds.  
Light gets darker to minimum brightness.

- i** Push-button: the light becomes brighter up to maximum brightness, remains there briefly and becomes dimmer down to minimum brightness, remains there briefly and becomes brighter again. This process repeats for as long as the push-button remains pressed.

### Switch light on with minimum brightness

- Press button at bottom for longer than 0.4 seconds.

### Save switch-on brightness

- Set light to the required brightness.
- Press button over entire surface for longer than 3 seconds.

Switch-on brightness is saved. For confirmation the lighting switches off briefly and then on again to the saved switch-on brightness.

- i** An push-button cannot be used to save the switch-on brightness.

## 5 Information for electrically skilled persons

### 5.1 Fitting and electrical connection



#### **DANGER!**

**Electrical shock when live parts are touched.**

**Electrical shocks can be fatal.**

**Before carrying out work on the device or load, disengage all the corresponding circuit breakers. Cover up live parts in the working environment.**

#### Fitting and electrical connection

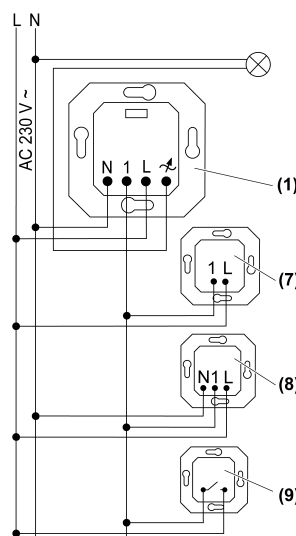

Figure 2: Connection diagram with optional extensions

- (1) FM insert
- (7) Extension insert, 2-wire
- (8) Extension insert, 3-wire
- (9) Push-button, NO contact

- i** HV-LED lamps and compact fluorescent lamps: Only connect lamps of one manufacturer and of the same type.
- i** Connect 600 Watt LED lamps or compact fluorescent lamps at most per 16 ampere circuit breaker.

**CAUTION!**

**Danger of destruction from mixed loads.**

**The dimmer and load may be destroyed.**

**Do not connect capacitive loads, e.g. electronic transformers, and inductive loads, e.g. inductive transformers, together on the same dimmer output.**

**Do not connect inductive transformers together with HV LED lamps or compact fluorescent lamps on the same dimmer output.**

- Connect the load according to connection diagram (figure 2).
- i** If no neutral conductor is available at the installation location, then the dimmer can also be operated without a neutral conductor. In this case, there is an increased likelihood of unsuitable combinations of dimmer and LED lamp.
- i** Power extension possible by means of power boosters. Make selection in accordance with the dimmer and load. Do not connect any LED lamps or compact fluorescent lamps in combination with power boosters.
- i** For extension units use the electric circuit of the main device.
- i** Illuminated push-buttons may only be connected if they have a separate N terminal.
  - Connect the extensions, optional.
  - Install insert in appliance box, device connection terminals must be at the bottom.
  - Perform commissioning.
- i** The light can be switched by briefly pressing the **Dimm-Mode** button (4).
- i** Do not attach or replace the cover under voltage, otherwise this might cause a malfunction.
  - Attach the frame (2) and the top (3).
  - Switch on mains voltage.

## 5.2 Commissioning

**DANGER!**

**Electrical shock when live parts are touched.**

**Electrical shocks can be fatal.**

**Use only insulated tools for the commissioning! Cover up live parts in the working environment.**

### Setting operating mode and minimum brightness

The operating mode (dimming principle) and minimum brightness can be set by an electrically skilled person to adapt the dimmer e.g. to an LED lamp.

The device is connected as described above, fitted in an appliance box and the load is connected. The frame and cover are not mounted.

**CAUTION!**

**Risk of destruction if the preset dimming principle and connected load do not match.**



**The dimmer and load may be destroyed.**



**Before changing the dimming principle, observe load type.**

**Before changing the load type, make sure that the dimming principle is correct.**

- Switch on mains voltage.
- Press button **Dimm-Mode** (4) (figure 1) for longer than 4 seconds.  
The LED (6) lights up in the colour of the current operating mode. The operating mode can be selected.

Operating mode	Function
----------------	----------

<p><b>R,L,C,HV-LED</b></p> <p>Universal LED turns green The operating mode is preset at the factory.</p>	<p>Automatic calibration to the load.</p> <p>Trailing edge phase control for incandescent lamps, HV halogen lamps, dimmable HV-LED or compact fluorescent lamps that can be dimmed according to the trailing edge phase control principle or electronic transformers with halogen or LED lamps.</p> <p>Leading edge phase control for dimmable inductive transformers with halogen or dimmable LED lamps.</p> <p>LED leading edge phase control for dimmable HV-LED or compact fluorescent lamps that can be dimmed according to the leading edge phase control principle.</p>
<p><b>HV-LED</b> </p> <p>LED trailing edge phase control LED turns red</p>	<p>Setting for incandescent lamps, HV halogen lamps, electronic transformers with halogen or LED lamps that can be dimmed according to the trailing edge phase control principle, dimmable HV-LED or compact fluorescent lamps that can be dimmed according to the trailing edge phase control principle. The connection of inductive transformers is not permitted.</p> <p>Select this operating mode for the highest possible output power.</p>
<p><b>HV-LED</b> </p> <p>LED leading edge phase control LED turns blue</p>	<p>Setting for incandescent lamps, electronic transformers with halogen or LED lamps that can be dimmed according to the leading edge phase control principle, HV halogen lamps or dimmable HV-LED or compact fluorescent lamps that can be dimmed according to the leading edge phase control principle. The connection of inductive transformers is not permitted.</p>

- Release button **Dimm-Mode** (4).
- Keep briefly pressing button **Dimm-Mode** (4) until the necessary operating mode is selected.  
The LED (6) lights up in the colour of the selected operating mode.
- Press the button **Dimm-Mode** (4) for longer than 4 seconds and keep it pressed.  
LED (6) flashes. Light switches on at the lowest brightness and slowly becomes brighter.
-  When changing the operating mode of LED leading edge phase control or trailing edge phase control to Universal, the automatic calibration to the load is first performed. Keep the **Dimm-Mode** button (4) pressed.
- Once the desired minimum brightness is reached, release the button **Dimm-Mode** (4).  
LED (6) lights up, operating mode and minimum brightness are set.  
If the button is not pressed after 30 seconds, the LED (6) goes out and the settings are saved.
-  Set the minimum brightness according to EN 60669-2-1 (01.2010).
-  If the minimum brightness was set too brightly, press the button **Dimm-Mode** (4) again for longer than 1 second. Light switches again to the lowest brightness and slowly becomes brighter.
- Switch off mains voltage.
- Mount frame and cover.
- Switch on mains voltage again.

## 6 Appendix

### 6.1 Technical data

Rated voltage	AC 230 V ~
Mains frequency	50 / 60 Hz
Standby power	max. 0.5 W
Power loss	max. 4.5 W
Ambient temperature	+5 ... +45 °C
Contact type	ε

Connected load at 25 °C

**i** Power specifications including transformer power dissipation.

**i** Operate inductive transformers with at least 85% nominal load.

Incandescent lamps 20 ... 420 W

HV halogen lamps 20 ... 420 W

Electronic transformers 20 ... 420 W

Electronic transformers with LV-LED typ. 20 ... 100 W

Inductive transformers 20 ... 420 VA

Inductive transformers with LV-LED typ. 20 ... 100 VA

**i** When operated without a neutral conductor, the minimum load for incandescent lamps, HV halogen lamps, electronic and inductive transformers increases to 50 W.

HV-LED lamps typ. 3 ... 100 W

Compact fl lamp. typ. 3 ... 100 W

Mixed load

ohmic-capacitive 20 ... 420 W

capacitive-inductive not permitted

ohmic-inductive 20 ... 420 VA

**i** For ohmic-inductive mixed load, maximum 50% proportion of ohmic load. Otherwise incorrect calibration of the dimmer may result.

**i** When operated without a neutral conductor, the minimum load for ohmic capacitive and ohmic inductive mixed load increases to 50 Watt.

**i** If the operating mode is manually set to **HV-LED**  LED trailing edge phase control, the maximum connected load for LED lamps increases to typ. 200 W.

Ohmic and HV LED typ. 3 ... 100 W

Ohmic and compact fl lamp. typ. 3 ... 100 W

Power reduction

per 5°C in excess of 25°C -10 %

when installed in wooden or dry construction walls -15 %

when installed in multiple combinations -20 %

Power boosters

See power booster instructions

Connection

single stranded max. 4 mm<sup>2</sup>

Finely stranded without conductor sleeve max. 4 mm<sup>2</sup>

Finely stranded with conductor sleeve max. 2.5 mm<sup>2</sup>

Number of extension units

Extension insert, 2-wire unlimited

Extension insert, 3-wire 5

Unlit push-buttons unlimited

Total length of extension unit cable max. 100 m

Total length power cable max. 100 m

### 6.2 Troubleshooting

#### Connected LED lamps or compact fluorescent lamps switch off in the lowest dimming position or flicker

Cause: The set minimum brightness is too low.

Increase minimum brightness.

**Connected lamps do not switch on in the lowest dimming position or only after a delay**

Cause: The set minimum brightness is too low.

Increase minimum brightness.

**Connected LED lamps or compact fluorescent lamps flicker or buzz, no correct dimming possible, device buzzes**

Cause 1: Lamps are not dimmable.

Check manufacturer's instructions.

Exchange lamps for another type.

Cause 2: Operating mode (dimming principle) and lamps do not optimally match.

Check operation in another operating mode, reduce connected load as well if necessary.

Set the operating mode manually using the **Dimm-Mode** button (4).

Exchange lamps for another type.

Cause 3: Dimmer is connected without neutral conductor.

Connect neutral conductor if possible, otherwise exchange lamp for another type.

**Connected LED lamps or compact fluorescent lamps in the lowest dimming position are too bright; dimming range is too small**

Cause 1: The set minimum brightness is too high.

Reduce minimum brightness.

Cause 2: Operating mode (dimming principle) does not optimally match the connected HV-LED lamps.

Check operation in another operating mode, reduce connected load as well if necessary.

Set the operating mode manually using the **Dimm-Mode** button (4).

Exchange HV-LED lamps for another type.

**The dimmer switches the load off briefly and then on again.**

Cause: short-circuit protection has tripped but now there is no longer a fault.

**The dimmer has switched off and the load cannot be switched on again**

Cause 1: overheating protection has tripped.

Disconnect dimmer from mains by switching off circuit breaker.

LED trailing edge phase control: Reduce the connected load. Exchange lamps for another type.

LED leading edge phase control: Reduce the connected load. Check operation in the LED trailing edge phase control setting. Exchange lamps for another type.

Let dimmer cool down for at least 15 minutes.

Switch circuit breakers and dimmer on again.

Cause 2: Surge protection has triggered.

LED trailing edge phase control: Check operation in the LED leading edge phase control setting, reduce connected load as well if necessary.

Exchange lamps for another type.

Cause 3: short-circuit protection has tripped.

Disconnect dimmer from mains by switching off circuit breaker.

Eliminate short-circuit.

Switch circuit breakers and dimmer on again.

**i** Short-circuit protection is not based on a conventional fuse, no metallic separation of the operational current.

Cause 4: load failure.

Check load, replace light bulb. For inductive transformers, check primary fuse.

---

**LED lamp is dimly lit when dimmer is switched off**

Cause: LED lamp is not suitable for this dimmer.

Use another type of LED lamp or an LED lamp of another manufacturer.

**6.3 Accessories**

Standard centre plate

Art. No. ..1561.07..

**6.4 Warranty**

The warranty follows about the specialty store in between the legal framework as provided for by law.

**ALBRECHT JUNG GMBH & CO. KG**

Volmestraße 1  
58579 Schalksmühle  
GERMANY

Telefon: +49 2355 806-0  
Telefax: +49 2355 806-204  
kundencenter@jung.de  
www.jung.de